

NE5534, NE5534A, SA5534, SA5534A LOW-NOISE OPERATIONAL AMPLIFIERS

SLOS070C – JULY 1979 – REVISED SEPTEMBER 2004

- Equivalent Input Noise Voltage . . . 3.5 nV/ $\sqrt{\text{Hz}}$ Typ
- Unity-Gain Bandwidth . . . 10 MHz Typ
- Common-Mode Rejection Ratio . . . 100 dB Typ
- High DC Voltage Gain . . . 100 V/mV Typ
- Peak-to-Peak Output Voltage Swing 32 V Typ With $V_{CC\pm} = \pm 18 \text{ V}$ and $R_L = 600 \Omega$
- High Slew Rate . . . 13 V/ μs Typ
- Wide Supply-Voltage Range $\pm 3 \text{ V}$ to $\pm 20 \text{ V}$
- Low Harmonic Distortion
- Offset Nulling Capability
- External Compensation Capability

NE5534, SA5534 . . . D (SOIC), P (PDIP),
OR PS (SOP) PACKAGE
NE5534A, SA5534A . . . D (SOIC) OR P (PDIP) PACKAGE
(TOP VIEW)

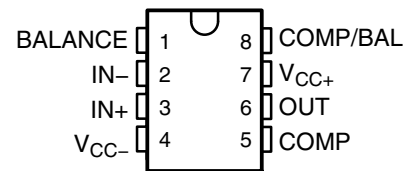

description/ordering information

The NE5534, NE5534A, SA5534, and SA5534A are high-performance operational amplifiers combining excellent dc and ac characteristics. Some of the features include very low noise, high output-drive capability, high unity-gain and maximum-output-swing bandwidths, low distortion, and high slew rate.

These operational amplifiers are compensated internally for a gain equal to or greater than three. Optimization of the frequency response for various applications can be obtained by use of an external compensation capacitor between COMP and COMP/BAL. The devices feature input-protection diodes, output short-circuit protection, and offset-voltage nulling capability with use of the BALANCE and COMP/BAL pins (see the *application circuit* diagram).

For the NE5534A and SA5534A, a maximum limit is specified for the equivalent input noise voltage.



Please be aware that an important notice concerning availability, standard warranty, and use in critical applications of Texas Instruments semiconductor products and disclaimers thereto appears at the end of this data sheet.

PRODUCTION DATA information is current as of publication date. Products conform to specifications per the terms of Texas Instruments standard warranty. Production processing does not necessarily include testing of all parameters.

 **TEXAS
INSTRUMENTS**

POST OFFICE BOX 655303 • DALLAS, TEXAS 75265

Copyright © 2004, Texas Instruments Incorporated

NE5534, NE5534A, SA5534. SA5534A LOW-NOISE OPERATIONAL AMPLIFIERS

SLOS070C – JULY 1979 – REVISED SEPTEMBER 2004

description/ordering information (continued)

ORDERING INFORMATION

T_A	V_{IOmax} AT 25°C	PACKAGE†	ORDERABLE PART NUMBER	TOP-SIDE MARKING	
0°C to 70°C	4 mV	PDIP (P)	Tube of 50	NE5534P	NE5534P
			Tube of 50	NE5534AP	NE5534AP
		SOIC (D)	Tube of 75	NE5534D	NE5534
			Reel of 2500	NE5534DR	
			Tube of 75	NE5534AD	5534A
			Reel of 2500	NE5534ADR	
SOP (PS)	Reel of 2000	NE5534PSR	N5534		
-40°C to 85°C	4 mV	PDIP (P)	Tube of 50	SA5534P	SA5534P
			Tube of 50	SA5534AP	SA5534AP
		SOIC (D)	Tube of 75	SA5534D	SA5534
			Reel of 2500	SA5534DR	
			Tube of 75	SA5534AD	SA5534A
			Reel of 2500	SA5534ADR	
		SOP (PS)	Tube of 80	SA5534PS	SA5534
			Reel of 2000	SA5534PSR	

† Package drawings, standard packing quantities, thermal data, symbolization, and PCB design guidelines are available at www.ti.com/sc/package.

schematic

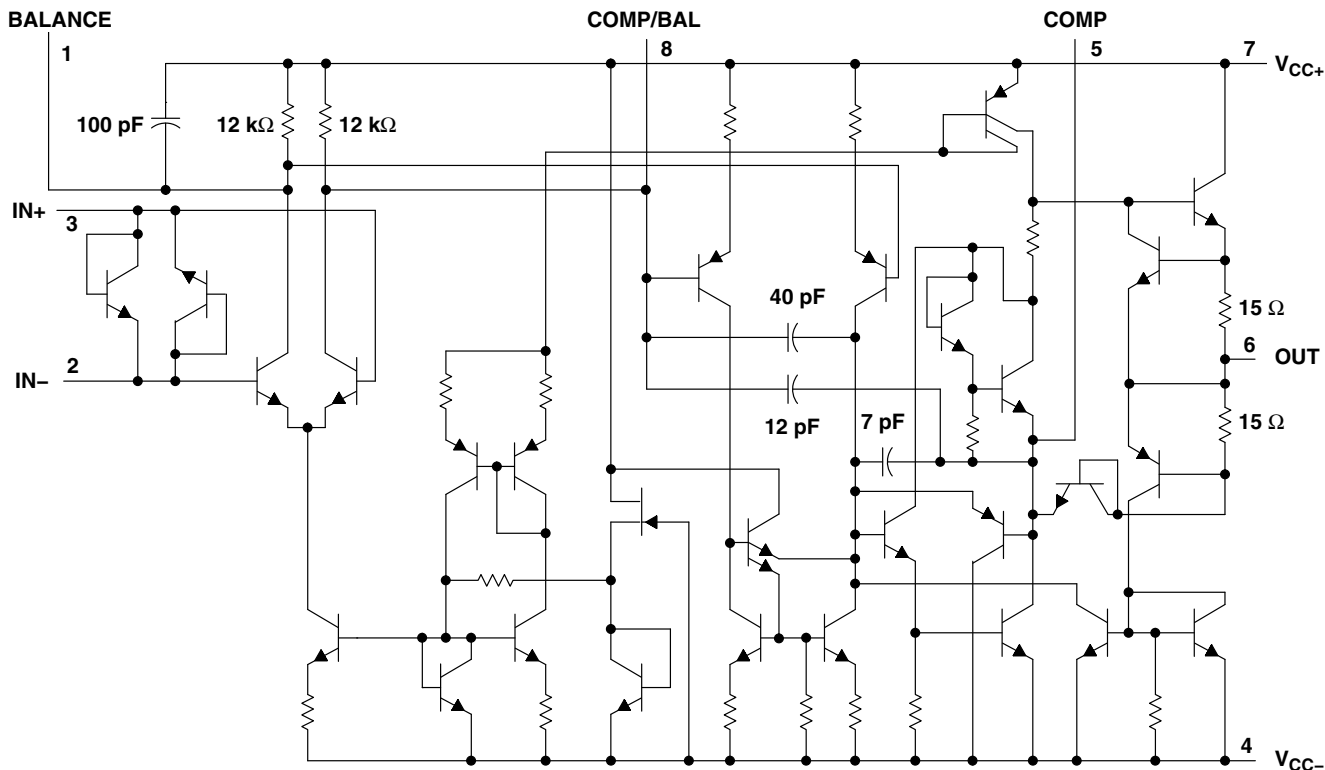

All component values shown are nominal.



POST OFFICE BOX 655303 • DALLAS, TEXAS 75265

NE5534, NE5534A, SA5534. SA5534A LOW-NOISE OPERATIONAL AMPLIFIERS

SLOS070C – JULY 1979 – REVISED SEPTEMBER 2004

symbol

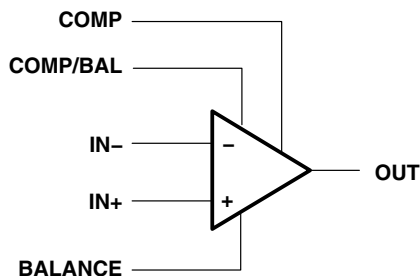

application circuit

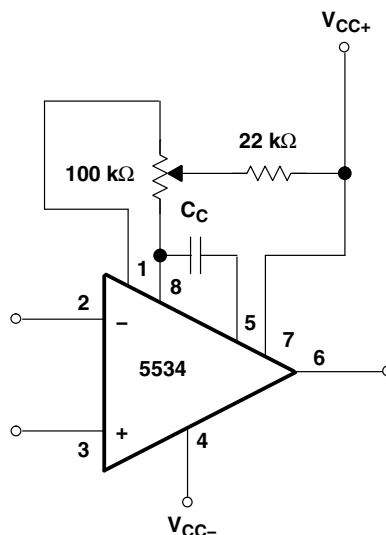

Frequency Compensation and Offset-Voltage Nulling Circuit

absolute maximum ratings over operating free-air temperature range (unless otherwise noted)[†]

Supply voltage: V_{CC+} (see Note 1)	22 V
V_{CC-} (see Note 1)	-22 V
Input voltage either input (see Notes 1 and 2)	V_{CC+}
Input current (see Note 3)	± 10 mA
Duration of output short circuit (see Note 4)	Unlimited
Package thermal impedance, θ_{JA} (see Notes 5 and 6):	
D package	97°C/W
P package	85°C/W
PS package	95°C/W
Operating virtual junction temperature, T_J	150°C
Storage temperature range, T_{stg}	-65°C to 150°C

[†] Stresses beyond those listed under "absolute maximum ratings" may cause permanent damage to the device. These are stress ratings only, and functional operation of the device at these or any other conditions beyond those indicated under "recommended operating conditions" is not implied. Exposure to absolute-maximum-rated conditions for extended periods may affect device reliability.

- NOTES:
- All voltage values, except differential voltages, are with respect to the midpoint between V_{CC+} and V_{CC-} .
 - The magnitude of the input voltage must never exceed the magnitude of the supply voltage.
 - Excessive current will flow if a differential input voltage in excess of approximately 0.6 V is applied between the inputs, unless some limiting resistance is used.
 - The output may be shorted to ground or to either power supply. Temperature and/or supply voltages must be limited to ensure the maximum dissipation rating is not exceeded.
 - Maximum power dissipation is a function of $T_J(\max)$, θ_{JA} , and T_A . The maximum allowable power dissipation at any allowable ambient temperature is $P_D = (T_J(\max) - T_A)/\theta_{JA}$. Operating at the absolute maximum T_J of 150°C can affect reliability.
 - The package thermal impedance is calculated in accordance with JESD 51-7.

recommended operating conditions

		MIN	MAX	UNIT
V_{CC+}	Supply voltage	5	15	V
V_{CC-}	Supply voltage	-5	-15	V
T_A	Operating free-air temperature range	NE5534, NE5534A	0	70
		SA5534, SA5534A	-40	85

NE5534, NE5534A, SA5534, SA5534A LOW-NOISE OPERATIONAL AMPLIFIERS

SLOS070C – JULY 1979 – REVISED SEPTEMBER 2004

electrical characteristics, $V_{CC\pm} = \pm 15\text{ V}$, $T_A = 25^\circ\text{C}$ (unless otherwise noted)

PARAMETER		TEST CONDITIONS†		MIN	TYP	MAX	UNIT
V_{IO}	Input offset voltage	$V_O = 0$, $R_S = 50\ \Omega$	$T_A = 25^\circ\text{C}$	0.5	4		mV
			$T_A = \text{Full range}$			5	
I_{IO}	Input offset current	$V_O = 0$	$T_A = 25^\circ\text{C}$	20	300		nA
			$T_A = \text{Full range}$			400	
I_{IB}	Input bias current	$V_O = 0$	$T_A = 25^\circ\text{C}$	500	1500		nA
			$T_A = \text{Full range}$			2000	
V_{ICR}	Common-mode input voltage range			± 12	± 13		V
$V_{O(PP)}$	Maximum peak-to-peak output voltage swing	$R_L \geq 600\ \Omega$	$V_{CC\pm} = \pm 15\text{ V}$	24	26		V
			$V_{CC\pm} = \pm 18\text{ V}$	30	32		
A_{VD}	Large-signal differential voltage amplification	$V_O = \pm 10\text{ V}$, $R_L \geq 600\ \Omega$	$T_A = 25^\circ\text{C}$	25	100		V/mV
			$T_A = \text{Full range}$	15			
A_{vd}	Small-signal differential voltage amplification	$f = 10\text{ kHz}$	$C_C = 0$		6		V/mV
			$C_C = 22\text{ pF}$		2.2		
B_{OM}	Maximum-output-swing bandwidth	$V_O = \pm 10\text{ V}$	$C_C = 0$		200		kHz
			$C_C = 22\text{ pF}$		95		
		$V_{CC\pm} = \pm 18\text{ V}$, $R_L \geq 600\ \Omega$,	$V_O = \pm 14\text{ V}$, $C_C = 22\text{ pF}$		70		
B_1	Unity-gain bandwidth	$C_C = 22\text{ pF}$,	$C_L = 100\text{ pF}$		10		MHz
r_i	Input resistance			30	100		k Ω
z_o	Output impedance	$A_{VD} = 30\text{ dB}$, $C_C = 22\text{ pF}$,	$R_L \geq 600\ \Omega$, $f = 10\text{ kHz}$		0.3		Ω
CMRR	Common-mode rejection ratio	$V_O = 0$, $R_S = 50\ \Omega$	$V_{IC} = V_{ICR\text{min}}$	70	100		dB
k_{SVR}	Supply-voltage rejection ratio ($\Delta V_{CC}/\Delta V_{IO}$)	$V_{CC+} = \pm 9\text{ V to } \pm 15\text{ V}$, $V_O = 0$	$R_S = 50\ \Omega$,	80	100		dB
I_{OS}	Output short-circuit current				38		mA
I_{CC}	Supply current	$V_O = 0$, No load	$T_A = 25^\circ\text{C}$		4	8	mA

† All characteristics are measured under open-loop conditions with zero common-mode input voltage, unless otherwise specified. For NE5534 and NE5534A, full range is 0°C to 70°C . For SA5534 and SA5534A, full range is -40°C to 85°C .

NE5534, NE5534A, SA5534. SA5534A LOW-NOISE OPERATIONAL AMPLIFIERS

SLOS070C – JULY 1979 – REVISED SEPTEMBER 2004

operating characteristics, $V_{CC} \pm = \pm 15\text{ V}$, $T_A = 25^\circ\text{C}$

PARAMETER		TEST CONDITIONS	NE5534, SA5534	NE5534A, SA5534A			UNIT
			TYP	MIN	TYP	MAX	
SR	Slew rate	$C_C = 0$	13	13			V/ μ s
		$C_C = 22\text{ pF}$	6	6			
t_r	Rise time	$V_I = 50\text{ mV}$, $A_{VD} = 1$, $R_L = 600\ \Omega$, $C_C = 22\text{ pF}$	20	20			ns
	Overshoot factor	$C_L = 100\text{ pF}$	20	20			%
	Rise time	$V_I = 50\text{ mV}$, $A_{VD} = 1$, $R_L = 600\ \Omega$, $C_C = 47\text{ pF}$	50	50			ns
	Overshoot factor	$C_L = 500\text{ pF}$	35	35			%
V_n	Equivalent input noise voltage	$f = 30\text{ Hz}$	7	5.5	7		nV/ $\sqrt{\text{Hz}}$
		$f = 1\text{ kHz}$	4	3.5	4.5		
I_n	Equivalent input noise current	$f = 30\text{ Hz}$	2.5	1.5			pA/ $\sqrt{\text{Hz}}$
		$f = 1\text{ kHz}$	0.6	0.4			
\bar{F}	Average noise figure	$R_S = 5\text{ k}\Omega$, $f = 10\text{ Hz to }20\text{ kHz}$		0.9			dB



NE5534, NE5534A, SA5534, SA5534A LOW-NOISE OPERATIONAL AMPLIFIERS

SLOS070C – JULY 1979 – REVISED SEPTEMBER 2004

TYPICAL CHARACTERISTICS†

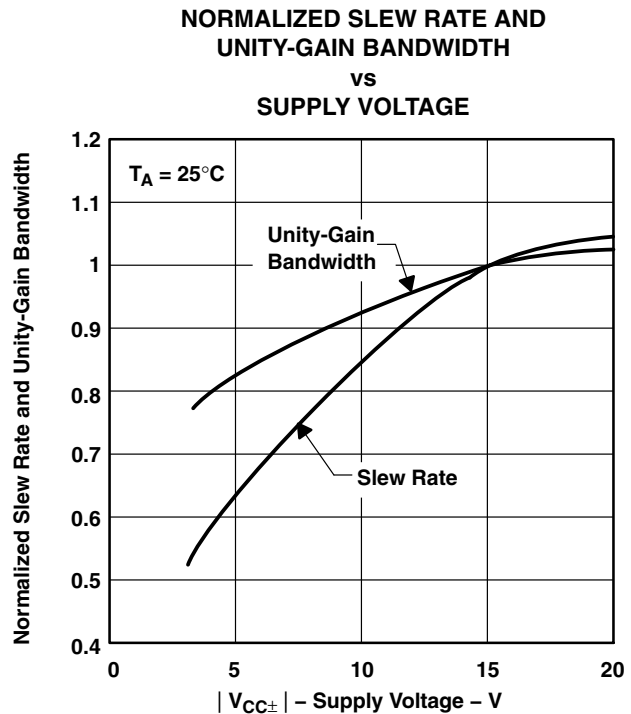
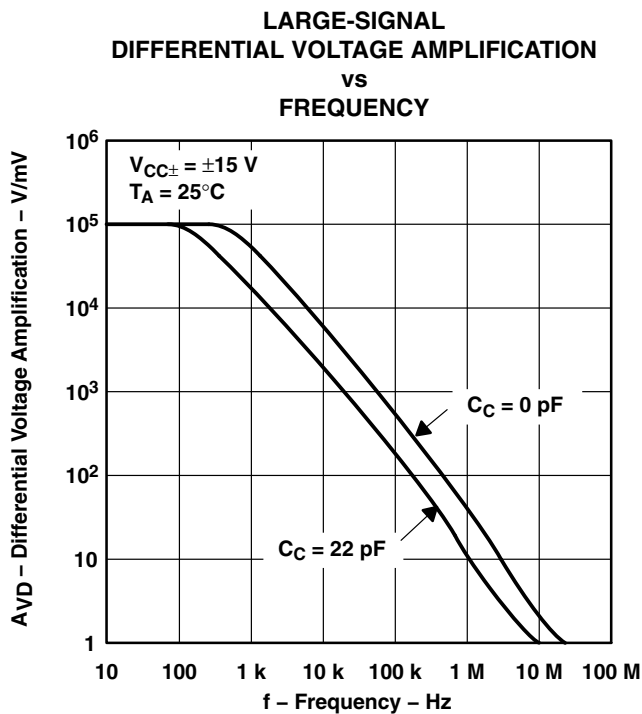
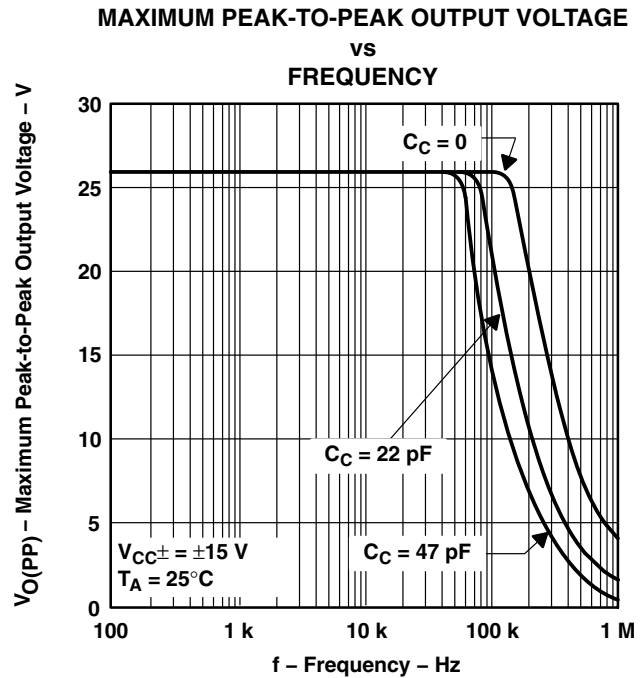
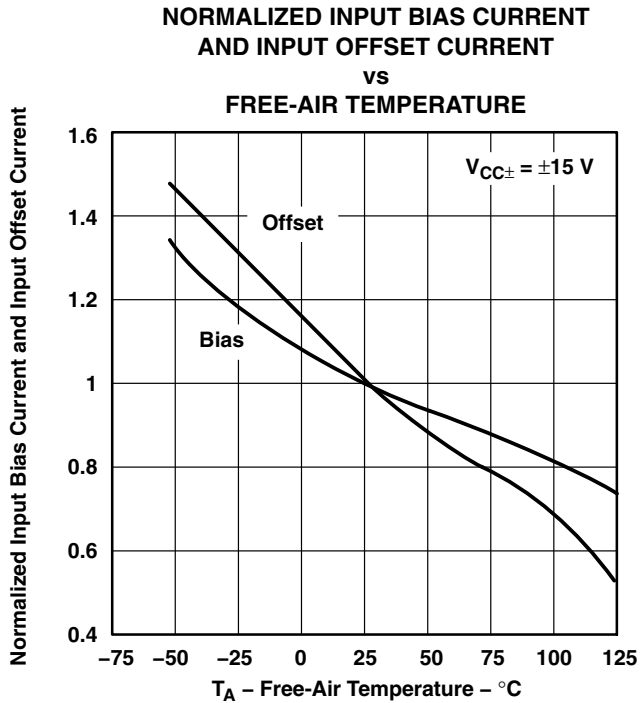

† Data at high and low temperatures are applicable only within the rated operating free-air temperature ranges of the various devices.

TYPICAL CHARACTERISTICS†

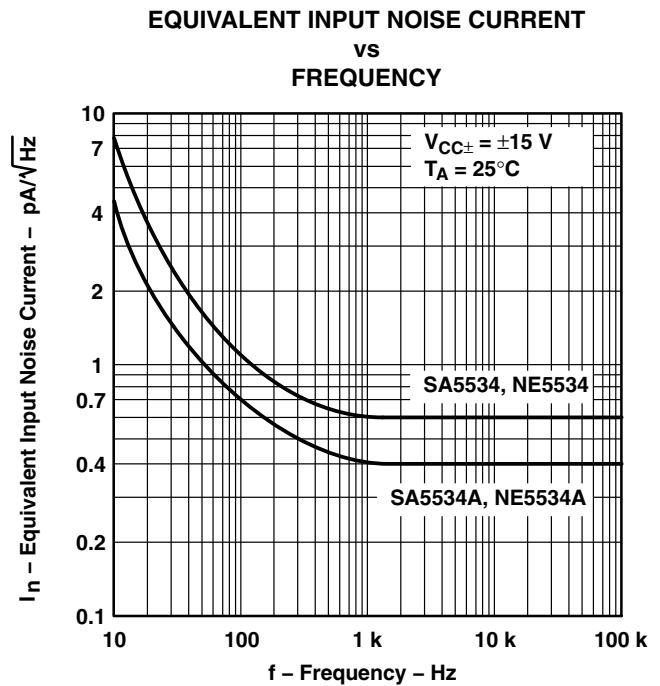
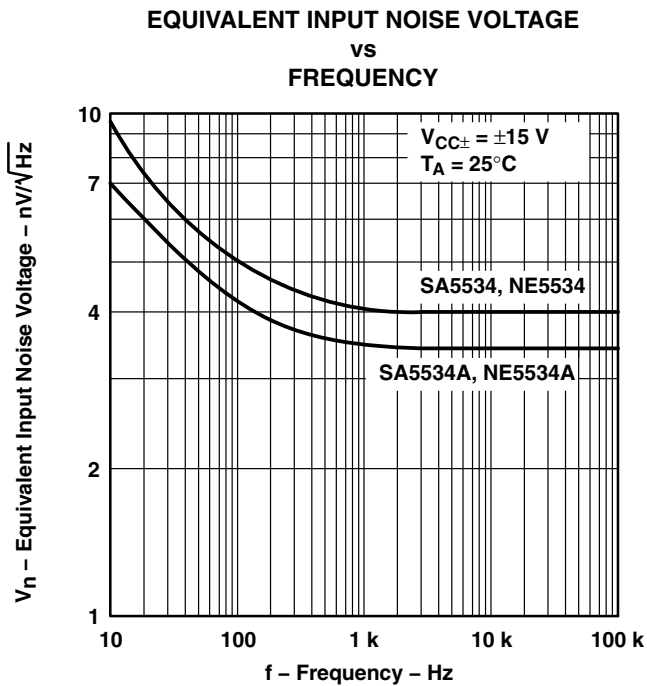
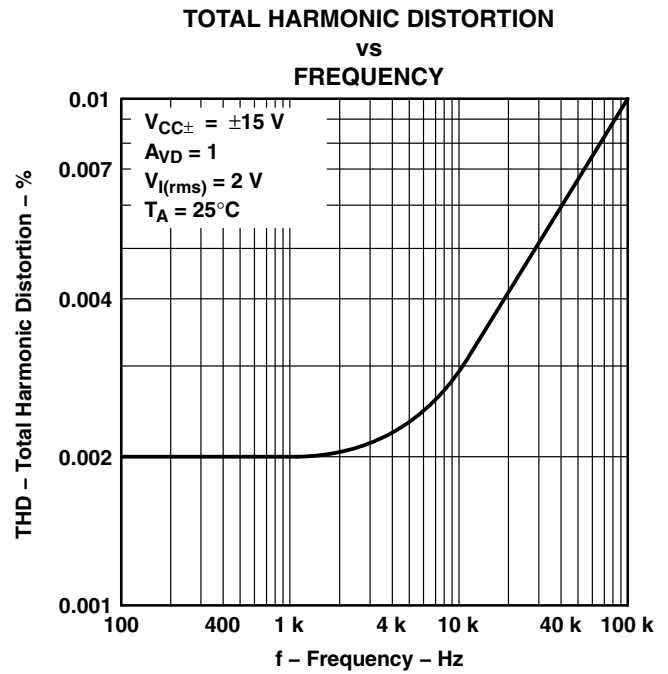
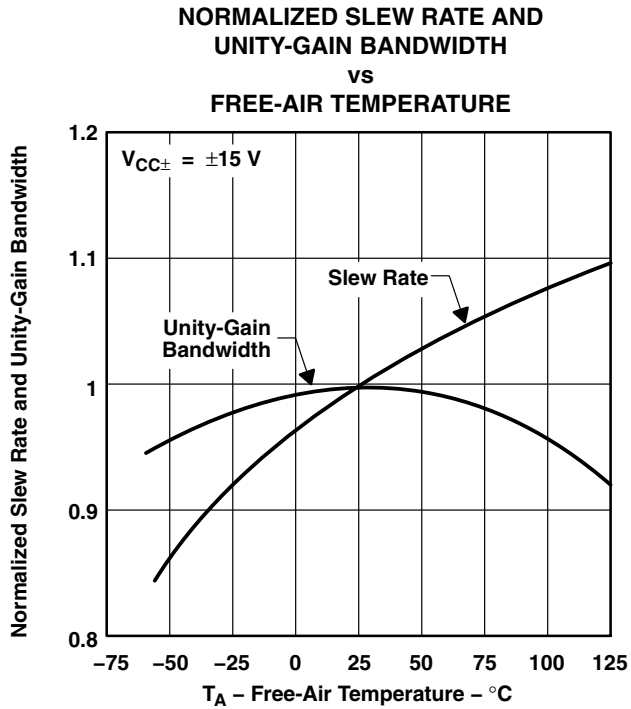

† Data at high and low temperatures are applicable only within the rated operating free-air temperature ranges of the various devices.

NE5534, NE5534A, SA5534. SA5534A LOW-NOISE OPERATIONAL AMPLIFIERS

SLOS070C – JULY 1979 – REVISED SEPTEMBER 2004

TYPICAL CHARACTERISTICS

TOTAL EQUIVALENT INPUT NOISE VOLTAGE vs SOURCE RESISTANCE

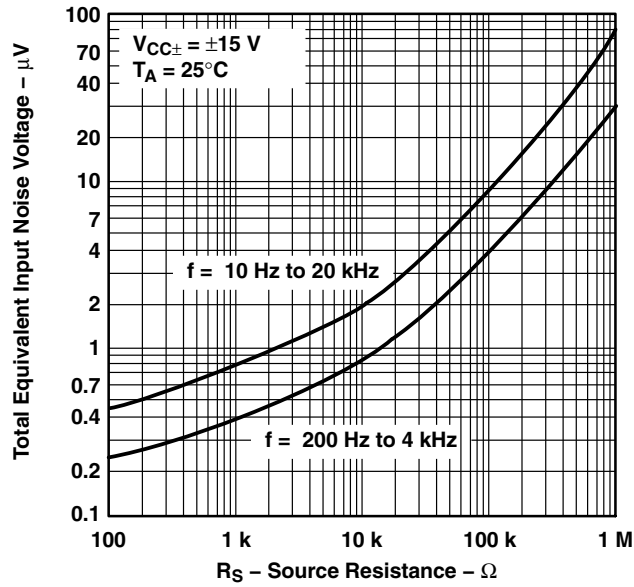

Figure 9

PACKAGING INFORMATION

Orderable Device	Status ⁽¹⁾	Package Type	Package Drawing	Pins	Package Qty	Eco Plan ⁽²⁾	Lead/ Ball Finish	MSL Peak Temp ⁽³⁾	Samples (Requires Login)
NE5534AD	ACTIVE	SOIC	D	8	75	Green (RoHS & no Sb/Br)	CU NIPDAU	Level-2-260C-1 YEAR	Purchase Samples
NE5534ADE4	ACTIVE	SOIC	D	8	75	Green (RoHS & no Sb/Br)	CU NIPDAU	Level-2-260C-1 YEAR	Purchase Samples
NE5534ADG4	ACTIVE	SOIC	D	8	75	Green (RoHS & no Sb/Br)	CU NIPDAU	Level-2-260C-1 YEAR	Purchase Samples
NE5534ADR	ACTIVE	SOIC	D	8	2500	Green (RoHS & no Sb/Br)	CU NIPDAU	Level-2-260C-1 YEAR	Contact TI Distributor or Sales Office
NE5534ADRE4	ACTIVE	SOIC	D	8	2500	Green (RoHS & no Sb/Br)	CU NIPDAU	Level-2-260C-1 YEAR	Contact TI Distributor or Sales Office
NE5534ADRG4	ACTIVE	SOIC	D	8	2500	Green (RoHS & no Sb/Br)	CU NIPDAU	Level-2-260C-1 YEAR	Contact TI Distributor or Sales Office
NE5534AJG	OBSOLETE	CDIP	JG	8		TBD	Call TI	Call TI	Samples Not Available
NE5534AP	ACTIVE	PDIP	P	8	50	Pb-Free (RoHS)	CU NIPDAU	N / A for Pkg Type	Contact TI Distributor or Sales Office
NE5534APE4	ACTIVE	PDIP	P	8	50	Pb-Free (RoHS)	CU NIPDAU	N / A for Pkg Type	Contact TI Distributor or Sales Office
NE5534D	ACTIVE	SOIC	D	8	75	Green (RoHS & no Sb/Br)	CU NIPDAU	Level-2-260C-1 YEAR	Contact TI Distributor or Sales Office
NE5534DE4	ACTIVE	SOIC	D	8	75	Green (RoHS & no Sb/Br)	CU NIPDAU	Level-2-260C-1 YEAR	Contact TI Distributor or Sales Office
NE5534DG4	ACTIVE	SOIC	D	8	75	Green (RoHS & no Sb/Br)	CU NIPDAU	Level-2-260C-1 YEAR	Contact TI Distributor or Sales Office
NE5534DR	ACTIVE	SOIC	D	8	2500	Green (RoHS & no Sb/Br)	CU NIPDAU	Level-2-260C-1 YEAR	Purchase Samples
NE5534DRE4	ACTIVE	SOIC	D	8	2500	Green (RoHS & no Sb/Br)	CU NIPDAU	Level-2-260C-1 YEAR	Purchase Samples
NE5534DRG4	ACTIVE	SOIC	D	8	2500	Green (RoHS & no Sb/Br)	CU NIPDAU	Level-2-260C-1 YEAR	Purchase Samples
NE5534IP	OBSOLETE	PDIP	P	8		TBD	Call TI	Call TI	Samples Not Available
NE5534P	ACTIVE	PDIP	P	8	50	Pb-Free (RoHS)	CU NIPDAU	N / A for Pkg Type	Contact TI Distributor or Sales Office
NE5534PE4	ACTIVE	PDIP	P	8	50	Pb-Free (RoHS)	CU NIPDAU	N / A for Pkg Type	Contact TI Distributor or Sales Office

Orderable Device	Status ⁽¹⁾	Package Type	Package Drawing	Pins	Package Qty	Eco Plan ⁽²⁾	Lead/ Ball Finish	MSL Peak Temp ⁽³⁾	Samples (Requires Login)
NE5534PSR	ACTIVE	SO	PS	8	2000	Green (RoHS & no Sb/Br)	CU NIPDAU	Level-1-260C-UNLIM	Purchase Samples
NE5534PSRE4	ACTIVE	SO	PS	8	2000	Green (RoHS & no Sb/Br)	CU NIPDAU	Level-1-260C-UNLIM	Purchase Samples
NE5534PSRG4	ACTIVE	SO	PS	8	2000	Green (RoHS & no Sb/Br)	CU NIPDAU	Level-1-260C-UNLIM	Purchase Samples
SA5534AD	ACTIVE	SOIC	D	8	75	Green (RoHS & no Sb/Br)	CU NIPDAU	Level-2-260C-1 YEAR	Purchase Samples
SA5534ADE4	ACTIVE	SOIC	D	8	75	Green (RoHS & no Sb/Br)	CU NIPDAU	Level-2-260C-1 YEAR	Purchase Samples
SA5534ADG4	ACTIVE	SOIC	D	8	75	Green (RoHS & no Sb/Br)	CU NIPDAU	Level-2-260C-1 YEAR	Purchase Samples
SA5534ADR	ACTIVE	SOIC	D	8	2500	Green (RoHS & no Sb/Br)	CU NIPDAU	Level-2-260C-1 YEAR	Contact TI Distributor or Sales Office
SA5534ADRE4	ACTIVE	SOIC	D	8	2500	Green (RoHS & no Sb/Br)	CU NIPDAU	Level-2-260C-1 YEAR	Contact TI Distributor or Sales Office
SA5534ADRG4	ACTIVE	SOIC	D	8	2500	Green (RoHS & no Sb/Br)	CU NIPDAU	Level-2-260C-1 YEAR	Contact TI Distributor or Sales Office
SA5534AP	ACTIVE	PDIP	P	8	50	Pb-Free (RoHS)	CU NIPDAU	N / A for Pkg Type	Contact TI Distributor or Sales Office
SA5534APE4	ACTIVE	PDIP	P	8	50	Pb-Free (RoHS)	CU NIPDAU	N / A for Pkg Type	Contact TI Distributor or Sales Office
SA5534D	ACTIVE	SOIC	D	8	75	Green (RoHS & no Sb/Br)	CU NIPDAU	Level-2-260C-1 YEAR	Purchase Samples
SA5534DE4	ACTIVE	SOIC	D	8	75	Green (RoHS & no Sb/Br)	CU NIPDAU	Level-2-260C-1 YEAR	Purchase Samples
SA5534DG4	ACTIVE	SOIC	D	8	75	Green (RoHS & no Sb/Br)	CU NIPDAU	Level-2-260C-1 YEAR	Purchase Samples
SA5534DR	ACTIVE	SOIC	D	8	2500	Green (RoHS & no Sb/Br)	CU NIPDAU	Level-2-260C-1 YEAR	Contact TI Distributor or Sales Office
SA5534DRE4	ACTIVE	SOIC	D	8	2500	Green (RoHS & no Sb/Br)	CU NIPDAU	Level-2-260C-1 YEAR	Contact TI Distributor or Sales Office
SA5534DRG4	ACTIVE	SOIC	D	8	2500	Green (RoHS & no Sb/Br)	CU NIPDAU	Level-2-260C-1 YEAR	Contact TI Distributor or Sales Office
SA5534P	ACTIVE	PDIP	P	8	50	Pb-Free (RoHS)	CU NIPDAU	N / A for Pkg Type	Contact TI Distributor or Sales Office

Orderable Device	Status ⁽¹⁾	Package Type	Package Drawing	Pins	Package Qty	Eco Plan ⁽²⁾	Lead/ Ball Finish	MSL Peak Temp ⁽³⁾	Samples (Requires Login)
SA5534PE4	ACTIVE	PDIP	P	8	50	Pb-Free (RoHS)	CU NIPDAU	N / A for Pkg Type	Contact TI Distributor or Sales Office
SA5534PS	ACTIVE	SO	PS	8	80	Green (RoHS & no Sb/Br)	CU NIPDAU	Level-1-260C-UNLIM	Purchase Samples
SA5534PSE4	ACTIVE	SO	PS	8	80	Green (RoHS & no Sb/Br)	CU NIPDAU	Level-1-260C-UNLIM	Purchase Samples
SA5534PSG4	ACTIVE	SO	PS	8	80	Green (RoHS & no Sb/Br)	CU NIPDAU	Level-1-260C-UNLIM	Purchase Samples
SA5534PSR	ACTIVE	SO	PS	8	2000	Green (RoHS & no Sb/Br)	CU NIPDAU	Level-1-260C-UNLIM	Contact TI Distributor or Sales Office
SA5534PSRE4	ACTIVE	SO	PS	8	2000	Green (RoHS & no Sb/Br)	CU NIPDAU	Level-1-260C-UNLIM	Contact TI Distributor or Sales Office
SA5534PSRG4	ACTIVE	SO	PS	8	2000	Green (RoHS & no Sb/Br)	CU NIPDAU	Level-1-260C-UNLIM	Contact TI Distributor or Sales Office

⁽¹⁾ The marketing status values are defined as follows:

ACTIVE: Product device recommended for new designs.

LIFEBUY: TI has announced that the device will be discontinued, and a lifetime-buy period is in effect.

NRND: Not recommended for new designs. Device is in production to support existing customers, but TI does not recommend using this part in a new design.

PREVIEW: Device has been announced but is not in production. Samples may or may not be available.

OBSOLETE: TI has discontinued the production of the device.

⁽²⁾ Eco Plan - The planned eco-friendly classification: Pb-Free (RoHS), Pb-Free (RoHS Exempt), or Green (RoHS & no Sb/Br) - please check <http://www.ti.com/productcontent> for the latest availability information and additional product content details.

TBD: The Pb-Free/Green conversion plan has not been defined.

Pb-Free (RoHS): TI's terms "Lead-Free" or "Pb-Free" mean semiconductor products that are compatible with the current RoHS requirements for all 6 substances, including the requirement that lead not exceed 0.1% by weight in homogeneous materials. Where designed to be soldered at high temperatures, TI Pb-Free products are suitable for use in specified lead-free processes.

Pb-Free (RoHS Exempt): This component has a RoHS exemption for either 1) lead-based flip-chip solder bumps used between the die and package, or 2) lead-based die adhesive used between the die and leadframe. The component is otherwise considered Pb-Free (RoHS compatible) as defined above.

Green (RoHS & no Sb/Br): TI defines "Green" to mean Pb-Free (RoHS compatible), and free of Bromine (Br) and Antimony (Sb) based flame retardants (Br or Sb do not exceed 0.1% by weight in homogeneous material)

⁽³⁾ MSL, Peak Temp. -- The Moisture Sensitivity Level rating according to the JEDEC industry standard classifications, and peak solder temperature.

Important Information and Disclaimer: The information provided on this page represents TI's knowledge and belief as of the date that it is provided. TI bases its knowledge and belief on information provided by third parties, and makes no representation or warranty as to the accuracy of such information. Efforts are underway to better integrate information from third parties. TI has taken and continues to take reasonable steps to provide representative and accurate information but may not have conducted destructive testing or chemical analysis on incoming materials and chemicals. TI and TI suppliers consider certain information to be proprietary, and thus CAS numbers and other limited information may not be available for release.

In no event shall TI's liability arising out of such information exceed the total purchase price of the TI part(s) at issue in this document sold by TI to Customer on an annual basis.

TAPE AND REEL INFORMATION



QUADRANT ASSIGNMENTS FOR PIN 1 ORIENTATION IN TAPE



*All dimensions are nominal

Device	Package Type	Package Drawing	Pins	SPQ	Reel Diameter (mm)	Reel Width W1 (mm)	A0 (mm)	B0 (mm)	K0 (mm)	P1 (mm)	W (mm)	Pin1 Quadrant
NE5534ADR	SOIC	D	8	2500	330.0	12.4	6.4	5.2	2.1	8.0	12.0	Q1
NE5534DR	SOIC	D	8	2500	330.0	12.4	6.4	5.2	2.1	8.0	12.0	Q1
NE5534PSR	SO	PS	8	2000	330.0	16.4	8.2	6.6	2.5	12.0	16.0	Q1
SA5534ADR	SOIC	D	8	2500	330.0	12.4	6.4	5.2	2.1	8.0	12.0	Q1
SA5534DR	SOIC	D	8	2500	330.0	12.4	6.4	5.2	2.1	8.0	12.0	Q1
SA5534PSR	SO	PS	8	2000	330.0	16.4	8.2	6.6	2.5	12.0	16.0	Q1

TAPE AND REEL BOX DIMENSIONS



*All dimensions are nominal

Device	Package Type	Package Drawing	Pins	SPQ	Length (mm)	Width (mm)	Height (mm)
NE5534ADR	SOIC	D	8	2500	340.5	338.1	20.6
NE5534DR	SOIC	D	8	2500	340.5	338.1	20.6
NE5534PSR	SO	PS	8	2000	346.0	346.0	33.0
SA5534ADR	SOIC	D	8	2500	340.5	338.1	20.6
SA5534DR	SOIC	D	8	2500	340.5	338.1	20.6
SA5534PSR	SO	PS	8	2000	346.0	346.0	33.0

JG (R-GDIP-T8)

CERAMIC DUAL-IN-LINE

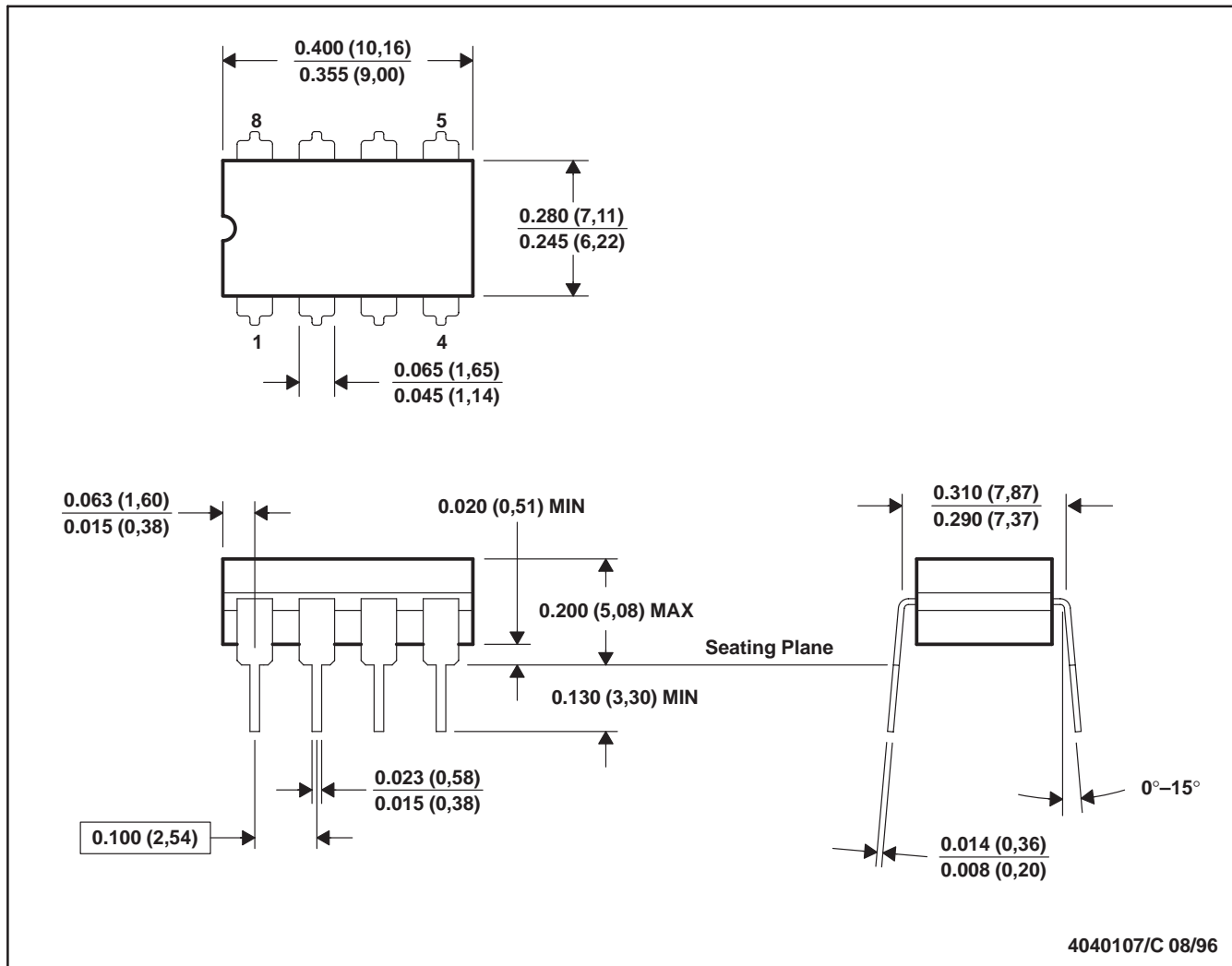

4040107/C 08/96

- NOTES: A. All linear dimensions are in inches (millimeters).
 B. This drawing is subject to change without notice.
 C. This package can be hermetically sealed with a ceramic lid using glass frit.
 D. Index point is provided on cap for terminal identification.
 E. Falls within MIL STD 1835 GDIP1-T8

P (R-PDIP-T8)

PLASTIC DUAL-IN-LINE PACKAGE



- NOTES:
- A. All linear dimensions are in inches (millimeters).
 - B. This drawing is subject to change without notice.
 - C. Falls within JEDEC MS-001 variation BA.

D (R-PDSO-G8)

PLASTIC SMALL-OUTLINE PACKAGE

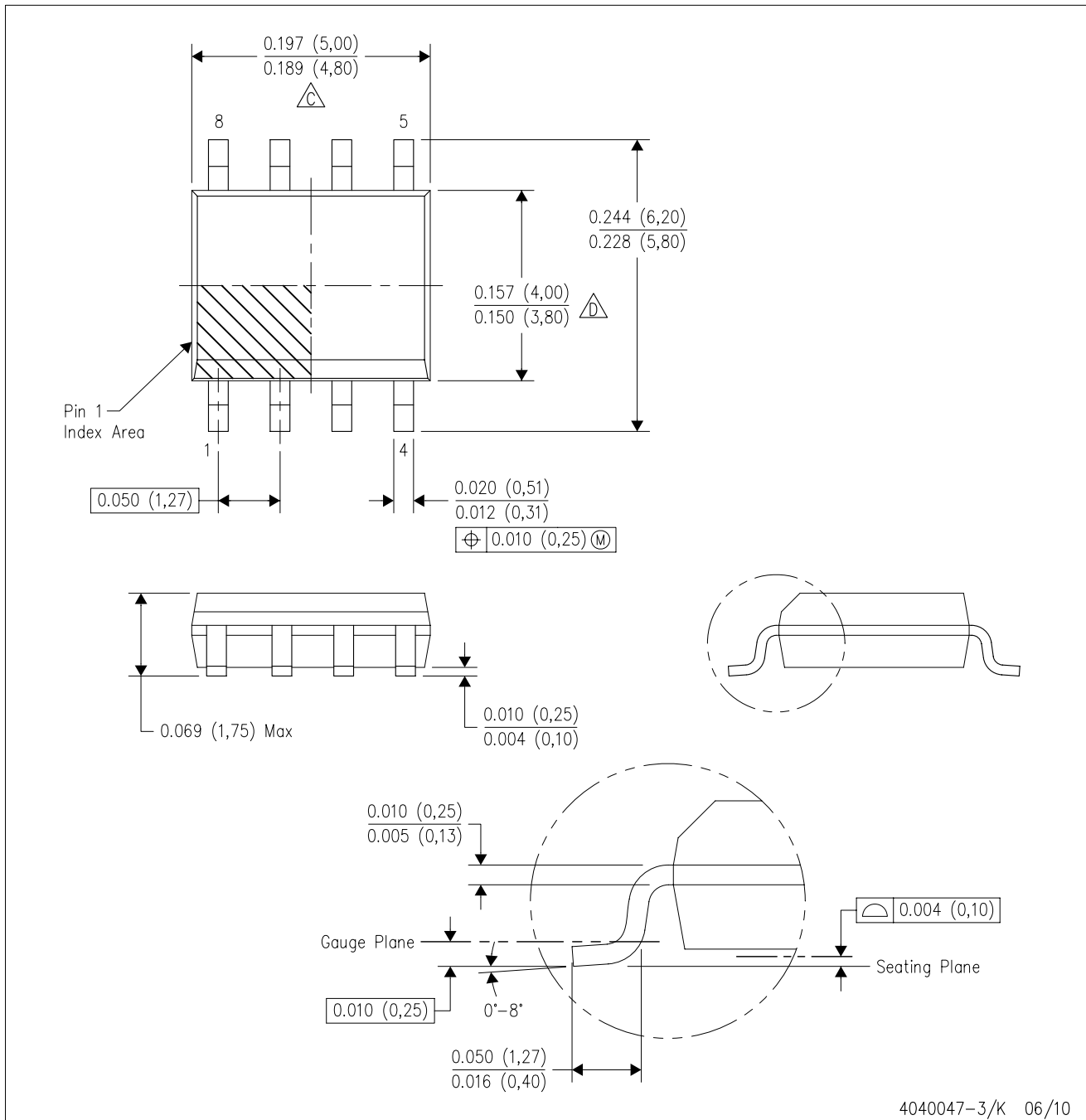

- NOTES:
- A. All linear dimensions are in inches (millimeters).
 - B. This drawing is subject to change without notice.
 - C. Body length does not include mold flash, protrusions, or gate burrs. Mold flash, protrusions, or gate burrs shall not exceed .006 (0,15) per end.
 - D. Body width does not include interlead flash. Interlead flash shall not exceed .017 (0,43) per side.
 - E. Reference JEDEC MS-012 variation AA.

IMPORTANT NOTICE

Texas Instruments Incorporated and its subsidiaries (TI) reserve the right to make corrections, modifications, enhancements, improvements, and other changes to its products and services at any time and to discontinue any product or service without notice. Customers should obtain the latest relevant information before placing orders and should verify that such information is current and complete. All products are sold subject to TI's terms and conditions of sale supplied at the time of order acknowledgment.

TI warrants performance of its hardware products to the specifications applicable at the time of sale in accordance with TI's standard warranty. Testing and other quality control techniques are used to the extent TI deems necessary to support this warranty. Except where mandated by government requirements, testing of all parameters of each product is not necessarily performed.

TI assumes no liability for applications assistance or customer product design. Customers are responsible for their products and applications using TI components. To minimize the risks associated with customer products and applications, customers should provide adequate design and operating safeguards.

TI does not warrant or represent that any license, either express or implied, is granted under any TI patent right, copyright, mask work right, or other TI intellectual property right relating to any combination, machine, or process in which TI products or services are used. Information published by TI regarding third-party products or services does not constitute a license from TI to use such products or services or a warranty or endorsement thereof. Use of such information may require a license from a third party under the patents or other intellectual property of the third party, or a license from TI under the patents or other intellectual property of TI.

Reproduction of TI information in TI data books or data sheets is permissible only if reproduction is without alteration and is accompanied by all associated warranties, conditions, limitations, and notices. Reproduction of this information with alteration is an unfair and deceptive business practice. TI is not responsible or liable for such altered documentation. Information of third parties may be subject to additional restrictions.

Resale of TI products or services with statements different from or beyond the parameters stated by TI for that product or service voids all express and any implied warranties for the associated TI product or service and is an unfair and deceptive business practice. TI is not responsible or liable for any such statements.

TI products are not authorized for use in safety-critical applications (such as life support) where a failure of the TI product would reasonably be expected to cause severe personal injury or death, unless officers of the parties have executed an agreement specifically governing such use. Buyers represent that they have all necessary expertise in the safety and regulatory ramifications of their applications, and acknowledge and agree that they are solely responsible for all legal, regulatory and safety-related requirements concerning their products and any use of TI products in such safety-critical applications, notwithstanding any applications-related information or support that may be provided by TI. Further, Buyers must fully indemnify TI and its representatives against any damages arising out of the use of TI products in such safety-critical applications.

TI products are neither designed nor intended for use in military/aerospace applications or environments unless the TI products are specifically designated by TI as military-grade or "enhanced plastic." Only products designated by TI as military-grade meet military specifications. Buyers acknowledge and agree that any such use of TI products which TI has not designated as military-grade is solely at the Buyer's risk, and that they are solely responsible for compliance with all legal and regulatory requirements in connection with such use.

TI products are neither designed nor intended for use in automotive applications or environments unless the specific TI products are designated by TI as compliant with ISO/TS 16949 requirements. Buyers acknowledge and agree that, if they use any non-designated products in automotive applications, TI will not be responsible for any failure to meet such requirements.

Following are URLs where you can obtain information on other Texas Instruments products and application solutions:

Products		Applications	
Amplifiers	amplifier.ti.com	Audio	www.ti.com/audio
Data Converters	dataconverter.ti.com	Automotive	www.ti.com/automotive
DLP® Products	www.dlp.com	Communications and Telecom	www.ti.com/communications
DSP	dsp.ti.com	Computers and Peripherals	www.ti.com/computers
Clocks and Timers	www.ti.com/clocks	Consumer Electronics	www.ti.com/consumer-apps
Interface	interface.ti.com	Energy	www.ti.com/energy
Logic	logic.ti.com	Industrial	www.ti.com/industrial
Power Mgmt	power.ti.com	Medical	www.ti.com/medical
Microcontrollers	microcontroller.ti.com	Security	www.ti.com/security
RFID	www.ti-rfid.com	Space, Avionics & Defense	www.ti.com/space-avionics-defense
RF/IF and ZigBee® Solutions	www.ti.com/lprf	Video and Imaging	www.ti.com/video
		Wireless	www.ti.com/wireless-apps

Mailing Address: Texas Instruments, Post Office Box 655303, Dallas, Texas 75265
Copyright © 2010, Texas Instruments Incorporated